

Viega Prevista

A new generation of pre-wall technology.



viega

CONTENTS

4

Viega Prevista. Co-developed by the top industry experts. By you.

6

The system. The key elements of successful bathroom planning.

8

The cistern. A top scorer in quality and use.

10

The cistern. Progress made easy.

12

The installation. Install quicker and more flexibly than ever before.

17

Viega Prevista. Tailored by design: to your needs.

18

Viega Prevista Pure. First choice in wet construction.

20

Viega Visign flush plates. Design that's in its element on every Viega pre-wall.

26

Viega Prevista. The flush plates.

28

The range: Viega Prevista.





Viega Prevista. A new generation.

CO-DEVELOPED BY THE TOP INDUSTRY EXPERTS. BY YOU.

A new generation of pre-wall technology has been created following a three-year development phase marked by intensive interchange with trade professionals. It is fit for the future in every way: It combines tried and tested technology with innovations which revolutionise working procedures, and delivers future-proof solutions in relation to hygiene, flexibility, digitalisation and design.

The result is a new generation of pre-wall technology which not only saves working time and makes planning and execution more reliable, but also fulfils all current and upcoming industry requirements – including yours too, without doubt.



viega.com/Prevista/Flushplate-configurator
A little about the field testing.



Enthralling technology.**The future for example.**

Viega Prevista is ready. To meet all the challenges of contributing to a healthy and hygienic future, and providing maximum flexibility and comfort in the home.

Hygiene

Healthy potable water, clean sanitary facilities and hygiene are basic needs. Viega's touchless flush plates are well suited to meeting all those demands, as are all the Viega products featuring hygiene functions which help to preserve potable water hygiene.

Digitalisation

Viega Prevista is the ideal platform for your digital transformation. Incorporating intelligent systems that will help to preserve potable water hygiene in future. And featuring new flush plates, touchless and lit by LEDs, that offer customers maximum comfort and hygiene.

Flexibility

Viega Prevista is ideal when it comes to meeting the demands of multi-generational living and delivering supreme levels of comfort. Individually adjustable toilet and washbasin elements and intelligent flush technologies significantly enhance users' lives.

Design

The bathroom is turning increasingly into a place of genuine well-being, featuring custom design elements. Viega Prevista is ideally suited to meeting those demands: with flush plates that perfectly combine form and function, and create the most exclusive bathroom ambience.

Find out more:
viega.com/Prevista

Viega Prevista. The system.

THE KEY ELEMENTS OF SUCCESSFUL BATHROOM PLANNING.

A time-saving installation starts with the right choices. That's why we have radically simplified them with Viega Prevista. The basis of the new pre-wall system is the new cistern, which is included in all applications.



The standardised cistern.

The Prevista Dry WC element for wall, support profile and rail mounting.

The Prevista Pure WC block for wet construction.

One cistern, three applications, tailored solutions

Viega Prevista offers you a choice of Prevista Dry for wall installation, Prevista Dry Plus for support profile and rail mounting, and Prevista Pure for wet construction.

All systems feature the same cistern. This means you can assemble and install your pre-wall system in super-quick time. Without having to think about which cistern matches which application and which flush plate. It's as easy as that!

Standard-compliant installation

The new Prevista pre-wall system complies with all the latest standards and regulations.

Fire protection and sealing

Viega Prevista fulfils all standard fire protection requirements, meaning it is

also suitable for installations in public amenities. At the same time, the new cistern and the reliable washbasin connections ensure that no moisture can penetrate into the wall or develop inside it. This helps avoid costly resultant damage.

Sound protection

The low-noise Viega Prevista pre-wall systems attenuate airborne and structure-borne sound efficiently – for quiet living and working.

Find out more:
[viega.com/Prevista/
Prewall-technology](https://www.viega.com/Prevista/Prewall-technology)

Prevista Dry/Prevista Dry Plus for dry construction



WC element



Washbasin element



Urinal element



Bidet element

1,120 mm with shower WC connection 6 cm height-adjustable	1,120 mm Height-adjustable crossbeams with quick-release clamps	1,120–1,300 mm Height-adjustable crossbeams with quick-release clamps, suitable for all urinal types	1,120 mm with universal positioning of the water connections
1,120 mm with shower WC connection	1,120 mm Fixed crossbeams	1,300 mm Height-adjustable crossbeams with quick-release clamps, telescopic water connection	
1,120 mm Property variant	1,120 mm Property variant with fixed crossbeams	1,120–1,300 mm Height-adjustable crossbeams with quick-release clamps, for concealed flush actuation	
980 mm with shower WC connection	980–820 mm Height-adjustable crossbeams with quick-release clamps		
820 mm with shower WC connection and operation from front or above			

Prevista Pure for wet construction



WC block



Washbasin block



Urinal block



Bidet block

1,077 mm	For walling-in
820 mm	

+

can be combined with all Prevista flush plates

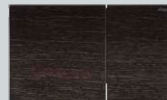
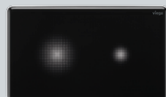

Viega Prevista. The cistern.

A TOP SCORER IN QUALITY AND USE.

The new Viega Prevista cistern is the core element of our new pre-wall system. Its compatibility, flexibility and durability assure optimum in-wall quality.



One cistern, every application

The new Prevista cistern is the basis of every new pre-wall system, and is identical in all Prevista WC elements. Regardless of whether a bathroom is designed as a dry or wet construction.

Standardised operation included

The method of use – in any case virtually self-explanatory – is always the same. This means the new Prevista cistern enables identical operation in every application.

Free choice of design

Because all new Viega Visign flush plates match the new cistern, custom design recommendations can be made in keeping with any installation scenario.

Quality made in Germany

The new, highly durable cistern is made in Germany. It is of course manufactured to the highest standards of sustainability,

and all its controls have a pleasing feel: All components have been optimised by industrial designers to provide the best user experience.

Perfect assurance

Each individual cistern is checked for leaks and its function tested prior to shipping, assuring maximum safety in application.

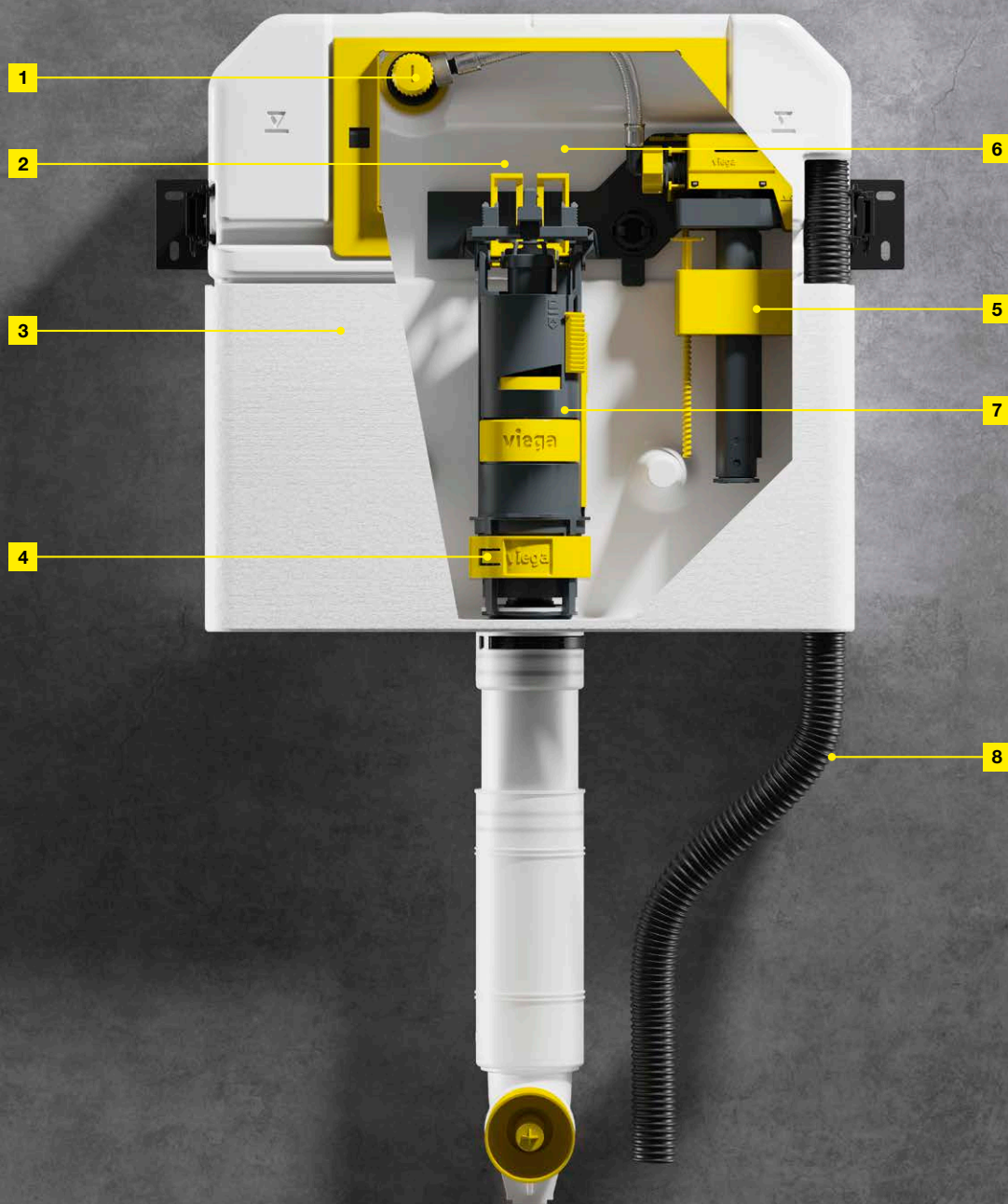

Water connection (Fig. 1)

The flexible Viega water connection connects to any piping system in a matter of seconds.

Flush plates (Fig. 2)

All new Viega flush plates can be used interchangeably for Prevista – and of course require no tools to install them.

Blow moulding (Fig. 3)

The new Prevista cistern is manufactured by the blow moulding technique. The cistern is blown into the mould from an extruded plastic tube. This assures maximum leak-tightness and reliable long-term quality without having to join individual elements.

Flexible flushing throttle (Fig. 4)

Enables the optimum flush flow to be set for all ceramics by adjusting a ring. Five settings permit the flow to be adapted to any standard commercially available ceramic.

Filling and draining valves (Fig. 5 & 7)

The filling and draining valves can be installed and removed without the use of tools.

Tablet holder (Fig. 6)

A holder for cleaning tablets can be added to the Viega Prevista cistern on request, providing easy and convenient ceramic hygiene.

Shower WC connection (Fig. 8)

Many Prevista Dry WC elements provide a connection for standard commercially available shower WCs. The shower WC connection set is available as an option.

Find out more:
[viega.com/Prevista/
 Prewall-technology](https://viega.com/Prevista/Prewall-technology)

Viega Prevista. The cistern.

PROGRESS MADE EASY.

The new Prevista pre-wall system incorporates lots of ideas aimed at making your work on-site easier. Its clearly defined operating concept will save you a lot of time right from the start – and enable you to install safety and comfort at the same Time.

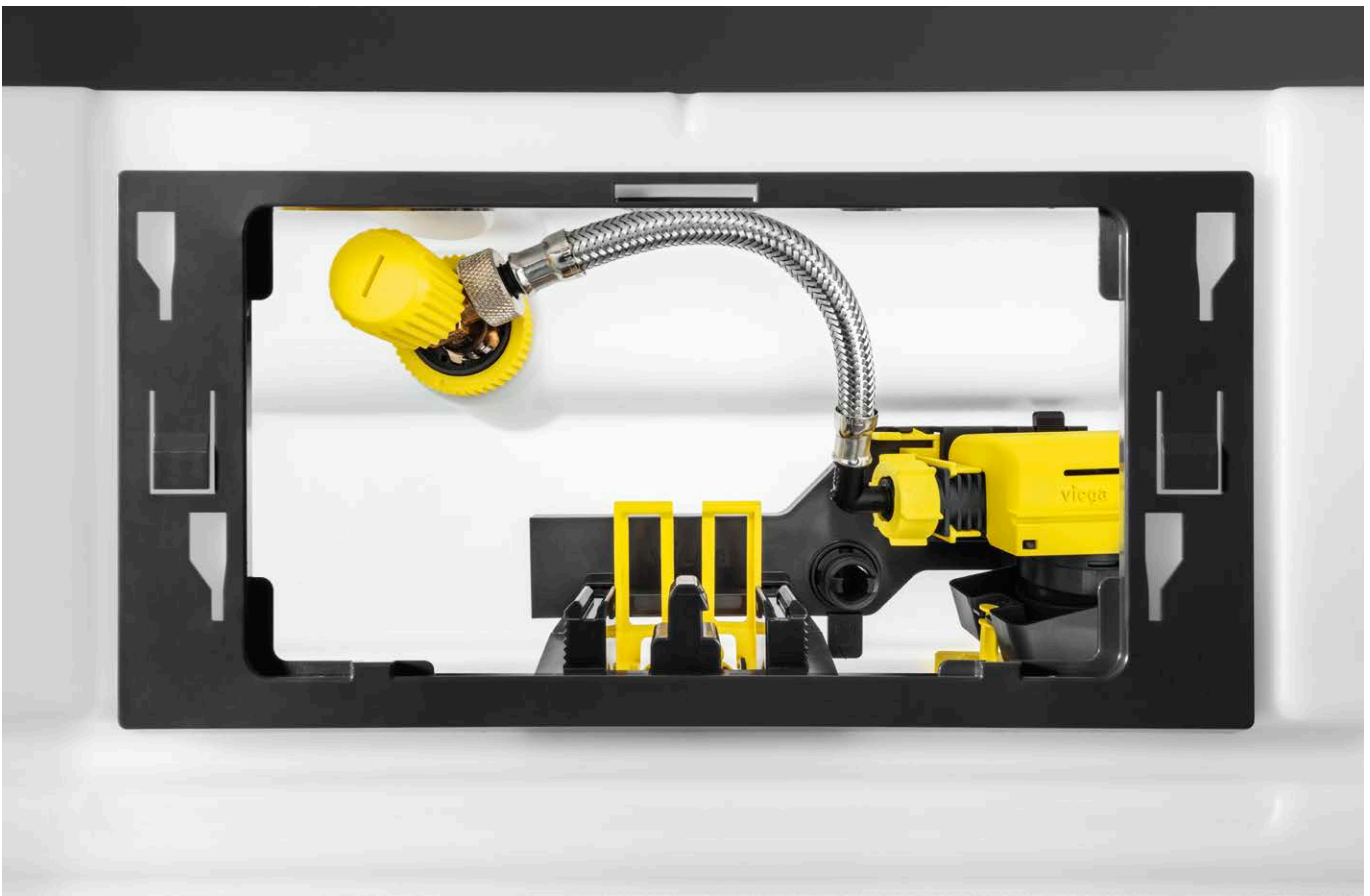

The colour yellow for self-explanatory operation

In the new Prevista pre-wall system, the components that are moveable and can be installed manually are coloured yellow. Whether the corner valve shut-off, the clips fastening the drain elbow, or the flush volume slide adjusters of the drain valve: the installation procedure and operation are self-explanatory.

Convenient, without tools: cistern operation

The benefits of the new Prevista operating concept are demonstrated particularly clearly by the new drain valve. The full or partial flush volume is adjusted by two yellow sliders; the flush flow is adjusted by a flushing throttle. When servicing the filling valve, standard commercially available spare parts will do the job if no Viega parts happen to be available.

Unbeatably flexible: the flush volumes

The new Prevista cistern features full flush volumes from 3.5 to 7.5 litres, and partial flush volumes from 2 to 4 litres. Custom settings are easily made. This enables the ideal combination of water saving and comfort to be found – entirely regardless of what type of ceramic is installed.



Find out more:
[viega.com/Prevista/Installation](https://www.viega.com/Prevista/Installation)



Installation videos

1 Folding away the two levers shortens the valve, making it easier to remove when servicing

2 Low flush volume set to 2–4 litres

3 Slider to adjust the high flush volume 3.5–7.5 litres

4 Integrated flushing throttle, adjustable in five stages



Easy to connect: the water connection

The water connection, featuring inside sealing, is equally impressive on the WC and washbasin elements: Its tool-free installation, easy post-installation alignment of the adapter and the facility to install the prefabricated piping system to the cistern and wall plate are great time-savers.

Viega Prevista. The installation.

INSTALL QUICKER AND MORE FLEXIBLY THAN EVER BEFORE.

The Viega Prevista installation concept helps our trade partners to achieve all their aims on-site. Whether rail-mounted, or directly on the wall: Installing Viega Prevista will save time and money every day.



Easy and very flexible

The new Viega Prevista pre-wall system makes work on-site easier in every respect. After the preparatory work, such as drilling the holes, it can be installed using just three tools: a folding rule, a spirit level and a size 13 spanner. Prevista Dry Plus rail mounting additionally requires a hexagon socket spanner to tighten the rail connectors.

Yellow for tool-free installation

The yellow marking of all manually installable elements is also applied to the installation of the pre-wall elements: The drain elbow clips, the fine adjuster of the wall mounting, the fixing of the flush plate frame and the removable revision shaft are all colour-coded in yellow to ensure quick and easy installation without the use of tools.



Prevista Dry wall bracket:
tool-free depth adjustment.



Prevista Dry installation: The base is simply bolted on.

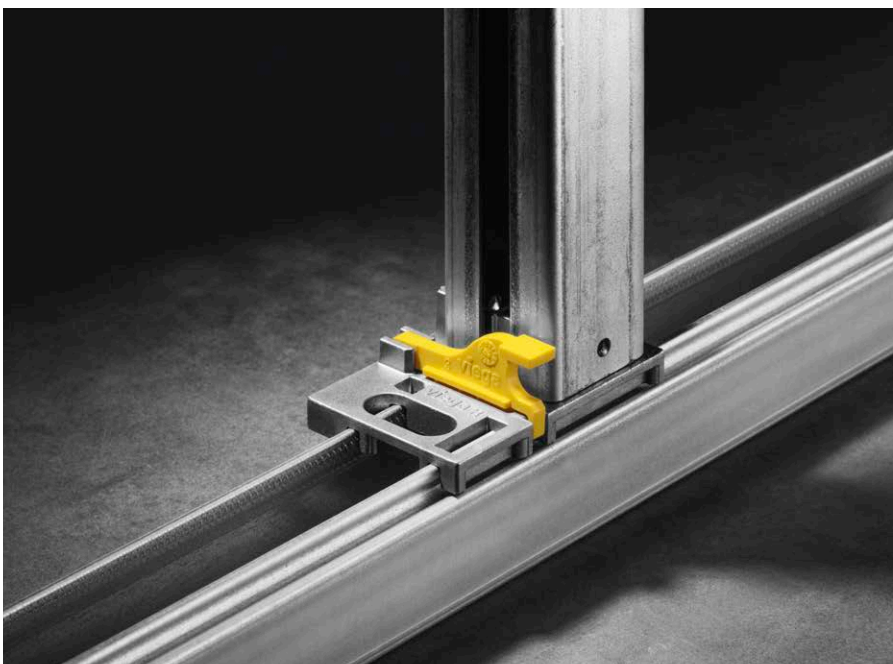

Prevista Dry Plus rail mounting: The base is simply positioned and clicked into place.

Prevista Dry:
quick wall mounting

Drill four holes, fit four screws, align once, and done: Prevista Dry is very easy to mount on the wall. Installation is not only aided by the new operating concept. Solutions such as the wall bracket, which attaches to the element, save additional valuable time on-site thanks to their flexibility. As the wall mounting method is identical for all elements – the WC and washbasin elements, and the urinal – the installation process is quick and self-explanatory.

Prevista Dry Plus:
quick rail mounting

The procedure for rail mounting is just as easy as the wall mounting method. The newly developed base is slotted into the rail and locked in place with a click – done. After aligning it and attaching it by the two connectors to the upper rail, all that is then necessary is to fit the water connections. It couldn't be any quicker, easier or more adaptable. In this way, Prevista Dry Plus greatly aids the planning and execution of custom bathroom designs.

Find out more:
veiga.com/Prevista/Installation



Installation videos

Viega Prevista. The installation.

SUPREME COMFORT BUILT-IN AS STANDARD.

One of the key concerns in future will be age-appropriate bathroom design. Viega Prevista has established the preconditions to meet those needs by making its installations height-adjustable as standard. At the same time, the facility to install a shower WC means that the very highest comfort demands can be met.





Quick and easy:
6 cm height adjustment as standard.



The water supply for the shower WC:
easy to install thanks to the integrated pipe.

Height adjustability ex factory

The Prevista Dry WC element's height can be adjusted by 6 cm as standard. After installing the pre-wall element on a wall or in a rail, the height of the WC can be adapted to users' needs. The default ex factory WC ceramic height of approximately 40 cm can be infinitely adjusted up to approximately 46 cm. The height of the pre-wall element does not change when the adjustment is made.

Shower WC preparation ...

Users also benefit from the supreme comfort offered by the standard shower WC preparation in Prevista Dry WC elements. The cold water supply is routed conveniently through the integrated pipe from the shower WC connection to the corner valve (cistern). A specially developed adapter for the corner valve permits parallel connection of the filling valve and shower WC in just a few seconds.



Shower WC connection in seconds: The adapter makes it possible.

... for all commonly installed shower WCs

Viega Prevista is designed to allow easy installation of shower WC ceramics and comfort solutions from the leading

manufacturers. So many new Prevista WC elements can be connected to virtually any available shower WC – another mark of the outstanding compatibility offered by Viega Prevista.

Find out more:
[viega.com/Prevista/Installation](https://www.viega.com/Prevista/Installation)



Installation videos

Viega Prevista. The installation.

INTELLIGENT: THE NEW QUICK-RELEASE CLAMPS.

The biggest job in pre-wall installation is adjusting the heights of individual crossbeams. So would could be a better idea than minimising the amount of time-consuming bolting involved, so as to completely revolutionise the process?

Super-quick adjustment

Adjusting the height of water connections or urinal drain outlets was previously a time-consuming job, because at least two bolts always had to be loosened and retightened in order to make quick adjustments to the pre-set height. The new Viega quick-release clamps have done away with that necessity.

Loosen, align, lock – done

Now the heights of water connections and urinal and washbasin drains can be adjusted by just a few actions: Open the quick-release clamp, correct the height, close the clamp again. The measurement scale on the right-hand side of the Prevista urinal and washbasin elements makes the alignment process especially easy.

Tested safety

The quick-release clamps provide a high degree of stability. Once locked, they hold components such as the crossbeam for the water connection on the washbasin securely in the Prevista pre-wall element, so assuring maximum long-term stability.



Viega Prevista.

TAILORED BY DESIGN: TO YOUR NEEDS.

A new-generation pre-wall technology must seek to meet all challenges. Viega Prevista's extensive selection of add-on elements enables individual customer wishes to be met.



Supreme comfort for everyone: the individually height-adjustable Prevista Dry WC element.



Perfect flexibility: individually height-adjustable washbasin element with support bracket.

Fig. 1 and 2 Unadulterated comfort: individual height adjustment

The individually height-adjustable Prevista WC and washbasin elements enable supreme comfort to be installed. Users can adjust the washbasin's height by 20 cm, and that of the WC by 8 cm. Both can be adjusted at the press of a button. The mechanism is covered by a high-grade glass panel – the perfect combination of comfort and design.

Fig. 2 Flexible: the support bracket

The Prevista support bracket is an ideal solution for the installation of customised partial-height pre-wall constructions. It can be used to increase the width of the pre-wall as desired, and to infinitely adjust its height. The support bracket is universally usable for installation heights from 820 mm to 1,300 mm.

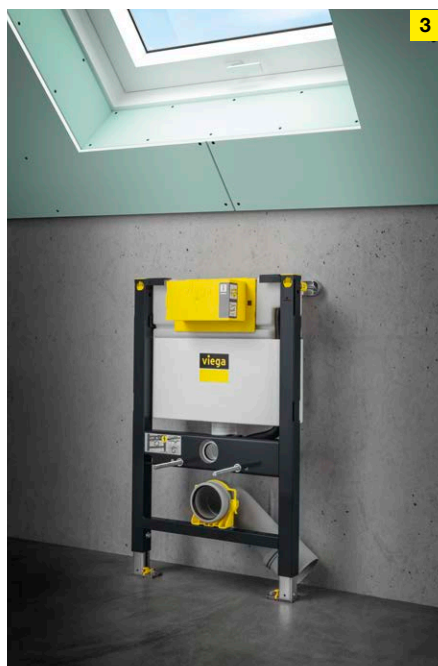

For low installation heights: the 820 mm high WC element.



For any application: the Prevista Dry urinal elements.

Fig. 3 Compact: the 820 mm element

The 820 mm high Prevista WC element enables convenient installation of a WC at low height, such as below sloping roofs or windows. Operation is optionally from above or from the front.

Fig. 4 Comfortable hygiene: the urinal elements

Viega Prevista offers three different urinal elements. The first variant – installed at heights from 1,120 to 1,300 mm – can be combined with all urinal types. The second, 1,300 mm high, element featuring a telescopic water connection is quick to install and suitable for many of the urinals commonly available on the market. Both variants are operated by mechanical and electronic flush plates. The third urinal element for concealed urinal controls is particularly well suited to bathrooms across a range of designs at heights from 1,120 to 1,300 mm.

Viega Prevista. The pre-wall blocks.

FIRST CHOICE IN WET CONSTRUCTION: PREVISTA PURE.

State-of-the-art pre-wall technology combined with tried and proven methods: With Prevista Pure and the new cistern, custom, high-grade, durable wet construction installations can be created.

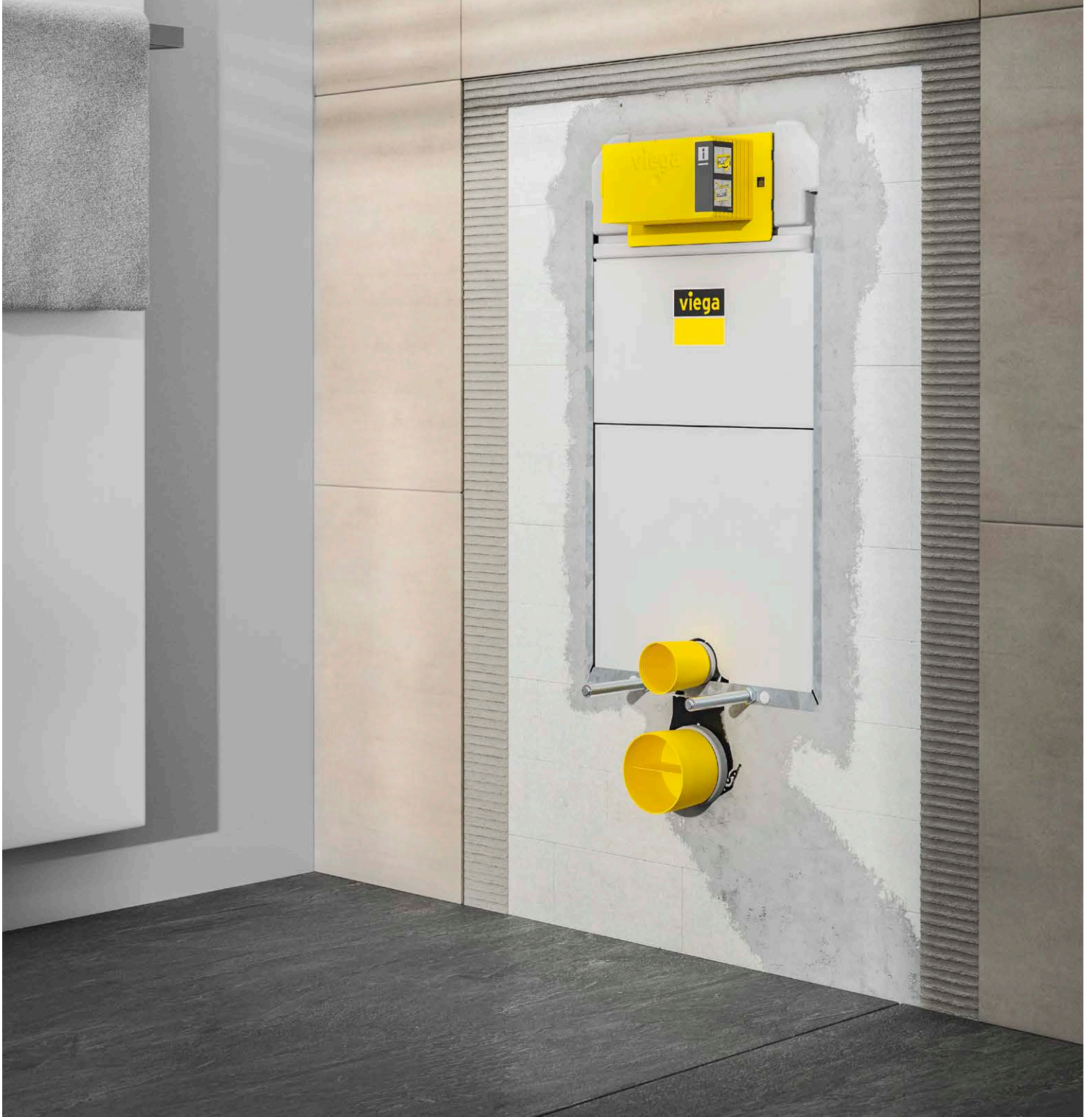



Flexibility and design

Viega Prevista Pure pre-wall blocks are perfectly tailored to wet construction demands, and impress through their great flexibility in single installations. There are two variants, featuring 820 mm and 1,077 mm installation heights. Both of them are compatible with all Viega flush plates for Prevista thanks to the new Prevista cistern. Alongside the WC block, blocks for the urinal, washbasin and bidet are also available. So everything is in place to ensure the planning of luxurious bathroom designs.

Fully pre-assembled

To make it easier for you, the interior fittings with the Viega Prevista cistern come fully pre-assembled, and permit operation from the front. The 820 mm variant can also be easily operated from above. The flexible depth adjustment additionally provides for improved variability.

Sound protection included

Noise when flushing a toilet should be avoided as far as possible. Viega Prevista Pure is enclosed in a housing to ensure quiet in the home and work environments.

Viega Visign. The new flush plates for Prevista.

DESIGN THAT'S IN ITS ELEMENT ON EVERY VIEGA PRE-WALL.

High-end design that can be installed on any pre-wall element: The new Viega flush plates for Prevista permit modern living spaces to be created in any bathroom.



Individual design for individual bathrooms

Because bathrooms are as diverse as their users, the Viega Visign portfolio offers the right flush plate for any bathroom and any taste: from emotional to rational; from purist to extravagant. The range of materials extends from veneered wood finishes, through brushed stainless steel, to glass and high-grade plastic in a wide variety of colours.

Flexibility installed without tools

The new Visign flush plates can be installed without the use of tools. And all new flush plates are compatible with the Prevista cistern. So the installed design is merely a question of taste, not of technical feasibility. Installation flush with tiles is possible, as is the fitting of a tablet holder to provide pleasant WC hygiene in conjunction with all Visign for Style and Visign for More plates.

Durable comfort

All Viega Visign flush plates for Prevista featuring manual flush can be ideally combined with the latest trends in ceramics and tiles, and also impress through their pleasing feel and ease of operation. And because all Visign flush plates are subjected to extensive endurance testing, they will last the lifetime of the bathroom.



Meeting the highest design demands: the frame for installation flush to tiles.

Free choice: five of 50 standard design variants

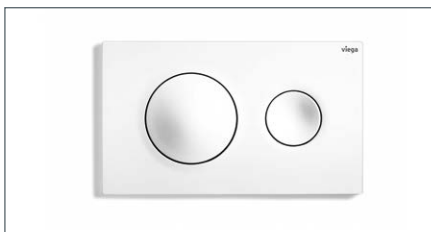

Visign for Style 20
Plastic, alpine white

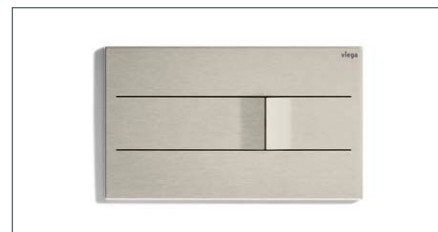

Visign for More 201
Brushed stainless steel



Visign for Style 23
Acrylic black/stainless steel coloured



Visign for More 204
Polished stainless steel

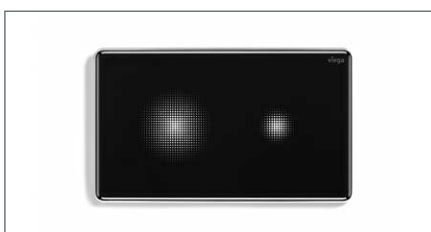

Visign for More 205 sensitive
Deep black glass

Find out more:
[viega.com/Prevista/
Flushplates-configurator](https://www.viega.com/Prevista/Flushplates-configurator)

Viega Visign. The new flush plates.

MAXIMUM HYGIENE TAKING UP MINIMAL SPACE.

When is top-class hygiene even more appealing? When it's combined with intelligent operating comfort. As in the touchless flush plates from Viega.



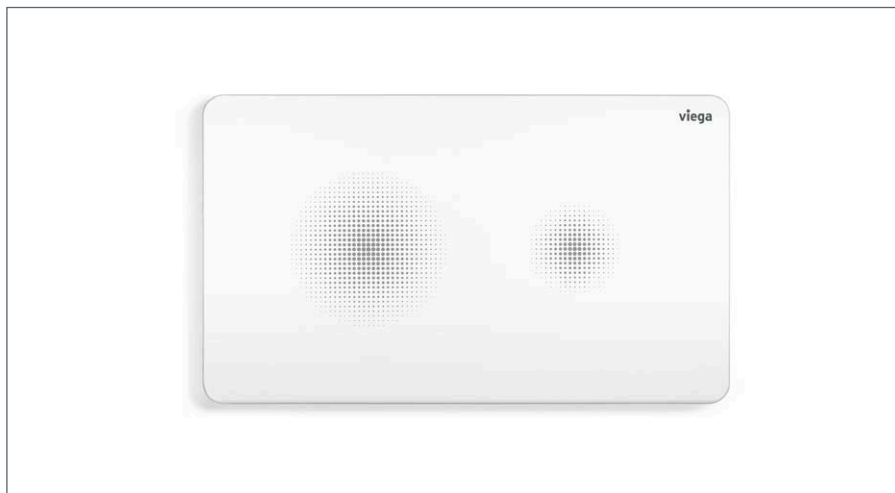

Visign for Style 25 sensitive, plastic, alpine white, featuring luminous paint to provide guidance in the dark.

The most appealing way to avoid touching something

Assuring exemplary cleanliness, easy to maintain, and attractive in design: The Viega Visign for More 205 sensitive and Visign for Style 25 sensitive touchless flush plates provide supreme flushing comfort and convenience in any bathroom. Both flush plates activate flushing when a hand is held close in front of the desired flush function on the plate. That means user enjoy maximum flushing comfort and convenience, while also avoiding germs and bacteria. The flush plates are as clean and durable as they are attractively designed: All surfaces are very easy to clean, and will retain their positive attributes for decades to come.

Programmable: the Viega Hygiene function

Assuring potable water quality is the top priority in public buildings where interruptions in use occur, such as in schools or hotels. Viega offers the ideal solution with its Hygiene concept. Looped-through line and circular installations combined with electronic flush plates help to preserve vital potable water hygiene. Additionally, an electronic control unit of the Viega Hygiene flushing system senses that no potable water is being tapped and ensures that regulation service is maintained when the installation is not in use, resulting in automatic, demand-oriented water exchange. Flushing is activated by a flush plate featuring the Viega Hygiene function. This can be programmed for all electronic flush plates.

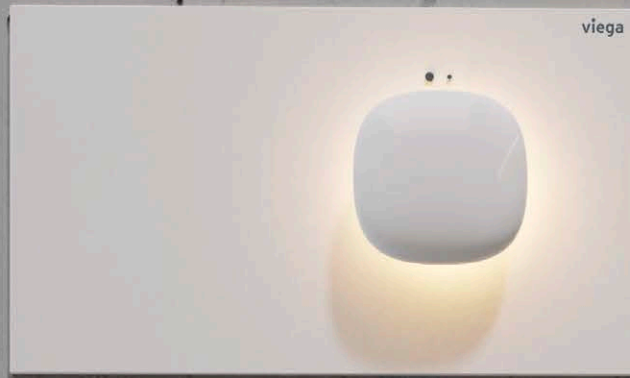

Viega Visign. The new flush plates for Prevista.

NOW INTEGRATED AS STANDARD: THE CONNECTION TO THE FUTURE.

Whether using advanced LED technology, or intelligent remote control: state-of-the-art pre-wall systems are designed to handle anything. As is Viega Prevista.

Modern bathroom, modern lighting

Lighting plays a key role in bathroom design. It not only enhances well-being, but also safety. Many Viega electronic flush plates can be equipped with LED

lights as an option. The pleasant neutral white serves as a guide and function illumination in the dark, yet is discreet enough to not clash with the bathroom lighting.

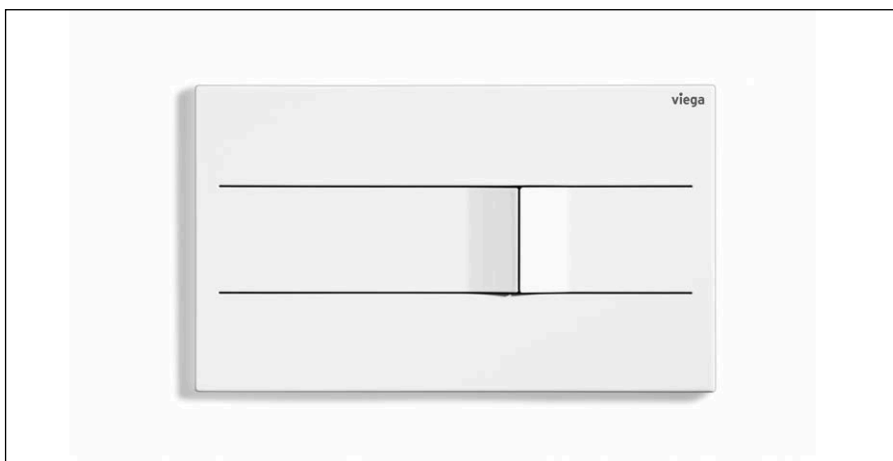

Whether in brushed or varnished stainless steel: The Visign for More 201 flush plate has a clearly defined look and feel, with slightly raised buttons.



With its slim brushed stainless steel flush, the Visign for More 204 looks like a pin badge fixed on the wall – a really smart decorative highlight for any designer bathroom.

Intelligent: the LED lighting

Design has many facets. Both the Visign for More 202 and the Visign for More 205 feature LED lighting as standard – the latter even incorporating intelligent programming: The LEDs are only activated when movement is detected in the room. The flush volume indicators light up when a hand is moved close to them. The Visign for More 201 and Visign for More 204 can optionally be equipped with an illuminated installation frame. It likewise responds when someone approaches, highlighting the flush plate with a pleasant ambient light.

opposite wall, or in a nearby item of furniture. Ideal for tight spaces, for people with restricted mobility, or simply for added convenience.

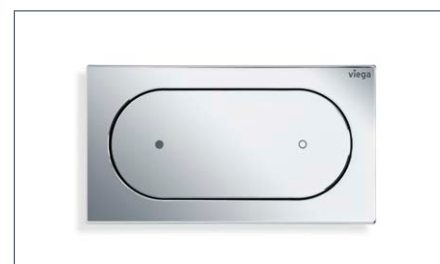

The Visign for Style 23 fits discreetly in any wall or furniture item. The low and high flush volumes are indicated by pressure points.

Convenient: the Visign remote flushes

User-friendly controls can also be installed in addition to intelligent lighting. The Visign for Style 23 and Visign for More 200 remote flushes permit users to actuate flushing from wherever is most convenient for them, for example around a corner, on the



Viega Prevista. The flush systems.

INVISIBLE INTELLIGENCE: IN-WALL FLUSH ACTUATORS.

Helping to assure maximum hygiene is not a luxury. Various flushing technologies, installed intelligently and invisibly in the wall, ensure exemplary hygiene in the home and in public facilities.

Hygiene meets design freedom: the concealed flush actuator

Assuring protection against vandalism for public amenities, and providing high levels of hygiene and purist design for private bathrooms: urinal flush actuation with no flush plate or cover plate.

This is made possible by the concealed flush actuator. A sensor located inside the urinal odour trap detects the changes in flow and temperature in use, and automatically activates flushing. The sensor additionally detects when the water level in the odour trap is too low

and tops it up with a flush to prevent odours from occurring. This combines maximum comfort and the greatest possible design freedom, with no need for a flush plate.

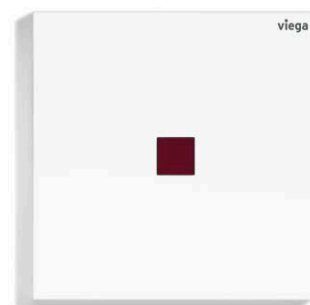

Convenient and hygienic: the infrared actuation.

Saving when everything is running at once

Interval at the concert? Half-time at the match? The concealed flush actuator is ideal for dealing with high-frequency usage. It saves water despite being operated so frequently, thanks to a dynamic flush program that detects sequential actuation and automatically reduces the flush volume from three litres to just one. Automatic flushing is also efficiently limited to once per minute. In addition, a useful diagnostic function provides easy readout and analysis of malfunctions. Flushing is disabled if the odour trap is blocked for example.

Infrared actuation

Touchless infrared flush actuation is particularly useful for the public and semi-public area. It combines high levels of comfort with exemplary hygiene: A sensor behind the cover plate detects use without any contact and automatically actuates flushing. Lifting a urinal cover does not result in a malfunction. Flushing is only actuated once the user moves away from the urinal. The flush volume and sensing range can be adjusted to the specific usage. The design is equally individual. Exquisite wood,

glass and plastic versions are available for private bathrooms. For public amenities, the portfolio includes a robust metal version with a vandal-proof bolt fitting.

Electronic actuation

Age-appropriate residential facilities, hospitals and care homes must in particular be fitted with flush actuators to aid toilet flushing. The new Viega electronic WC flush plates enable this based on flush actuation by various signals, such as radio signals, light barriers, motion detectors, pushbuttons or contact elements, which activate the motor unit. It is also possible to wire the signals simultaneously using an extension adapter. These electronic flush actuators can be used in the new Viega Prevista cistern and in combination with all Visign electronic flush plates. A mains connection in the pre-wall has to be considered in planning.

Viega Prevista.

THE RANGE: FLUSH PLATES.

Whether touchless, programmable, or featuring LED lighting: The range of colours and styles of the Viega Visign flush plates enables custom design. Additional variants beyond the example colours shown here can be found in the flush plates brochure and in the online configurator – viega.com/Prevista/Flushplates-configurator

8620.1

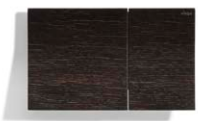

8621.1



8622.1



8610.1



8611.1



8613.1



8630.1



8631.1



8635.1



8640.1



8641.1



8610.2



8611.2



8613.2



8650.1



8651.1



8651.2





8624.1

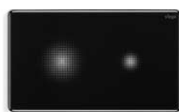

8625.1



8614.1



8615.1



8620.2



8653.1

Viega Prevista.

THE RANGE: PRE-WALL ELEMENTS.

The new Prevista pre-wall elements offer top quality made in Germany.
Always closely focused on maximum flexibility and top performance of course.



8502



8512



8516



8521



8522



8521.32



8522.31



8522.33



8530



8533



8535



8535.31



8535.32



8535.33



8536



8536.31



8537



8540



8540.31



8540.32



8540.33



8545



8545.31



8545.32



8550

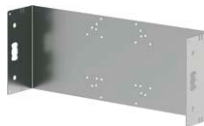

8555.34



8555.38



8560



8560.31



8560.32



8568



8569



8570.31



8570.32



8570.32



8570.36

INT 768 768-3/19-118138 . We reserve the right to effect changes.



Viega Holding GmbH & Co. KG

Viega Platz 1
57439 Attendorn
Germany

Phone +49 (0) 2722 61-0

viega.com

